



**JSCJ TO-92MOD Plastic-Encapsulate Transistors**

**2SA1013** TRANSISTOR (PNP)

**FEATURE**

- High Voltage:  $V_{CEO} = -160V$
- Large Continuous Collector Current Capability
- Complementary to 2SC2383

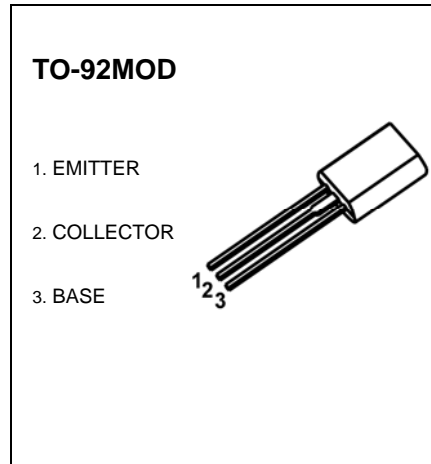

**MARKING**



A1013=Device code  
 Solid dot= Green molding compound device,  
 if none, the normal device  
 XXX=Code

**Equivalent Circuit**

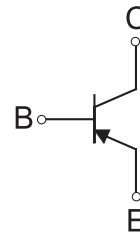

**ORDERING INFORMATION**

Part Number	Package	Packing Method	Pack Quantity
2SA1013	TO-92MOD	Bulk	500pcs/Bag
2SA1013-TA	TO-92MOD	Tape	2000pcs/Box

**MAXIMUM RATINGS** ( $T_a = 25^\circ C$  unless otherwise noted)

Symbol	Parameter	Value	Unit
$V_{CBO}$	Collector-Base Voltage	-160	V
$V_{CEO}$	Collector-Emitter Voltage	-160	V
$V_{EBO}$	Emitter-Base Voltage	-6	V
$I_C$	Collector Current -Continuous	-1	A
$P_C$	Collector Power Dissipation	0.9	W
$T_J, T_{stg}$	Operation Junction and Storage Temperature Range	-55 to +150	$^\circ C$

## ELECTRICAL CHARACTERISTICS

$T_a=25^\circ\text{C}$  unless otherwise specified

Parameter	Symbol	Test conditions	Min	Max	Unit
Collector-base breakdown voltage	$V(\text{BR})_{\text{CBO}}$	$I_{\text{C}}=-100\mu\text{A}$ , $I_{\text{E}}=0$	-160		V
Collector-emitter breakdown voltage	$V(\text{BR})_{\text{CEO}}$	$I_{\text{C}}=-1\text{mA}$ , $I_{\text{B}}=0$	-160		V
Emitter-base breakdown voltage	$V(\text{BR})_{\text{EBO}}$	$I_{\text{E}}=-10\mu\text{A}$ , $I_{\text{C}}=0$	-6		V
Collector cut-off current	$I_{\text{CBO}}$	$V_{\text{CB}}=-150\text{V}$ , $I_{\text{E}}=0$		-1	$\mu\text{A}$
Emitter cut-off current	$I_{\text{EBO}}$	$V_{\text{EB}}=-6\text{V}$ , $I_{\text{C}}=0$		-1	$\mu\text{A}$
DC current gain	$h_{\text{FE}}$	$V_{\text{CE}}=-5\text{V}$ , $I_{\text{C}}=-200\text{mA}$	60	320	
Collector-emitter saturation voltage	$V_{\text{CE(sat)}}$	$I_{\text{C}}=-500\text{mA}$ , $I_{\text{B}}=-50\text{mA}$		-1.5	V
Base-emitter voltage	$V_{\text{BE}}$	$I_{\text{C}}=-5\text{mA}$ , $V_{\text{CE}}=-5\text{V}$	-0.45	-0.75	V
Transition frequency	$f_{\text{T}}$	$V_{\text{CE}}=-5\text{V}$ , $I_{\text{C}}=-200\text{mA}$	15		MHz
Collector Output capacitance	$C_{\text{ob}}$	$V_{\text{CB}}=-10\text{V}$ , $I_{\text{E}}=0$ , $f=1\text{MHz}$		35	pF

### CLASSIFICATION OF $h_{\text{FE}}$

Rank	R	O	Y
Range	60-120	100-200	160-320

# Typical Characteristics

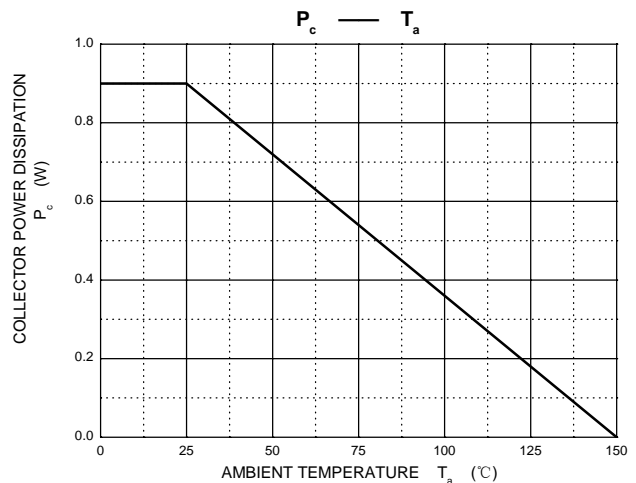
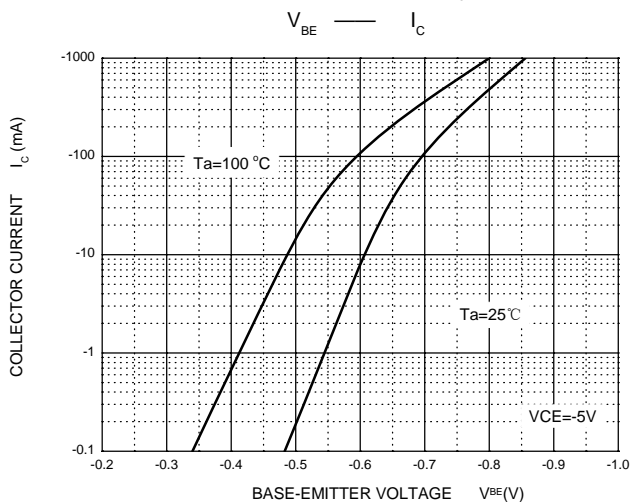
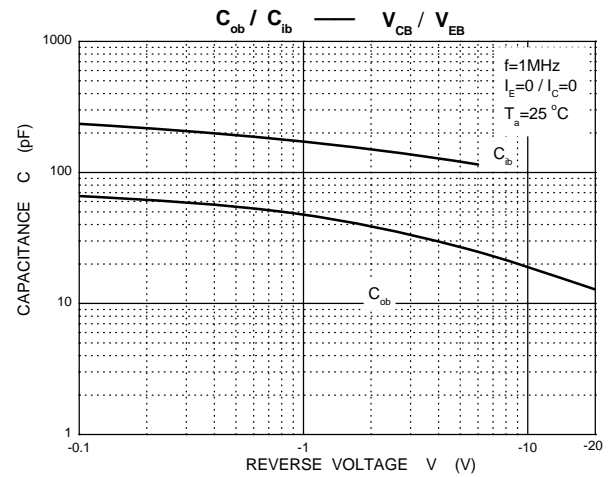
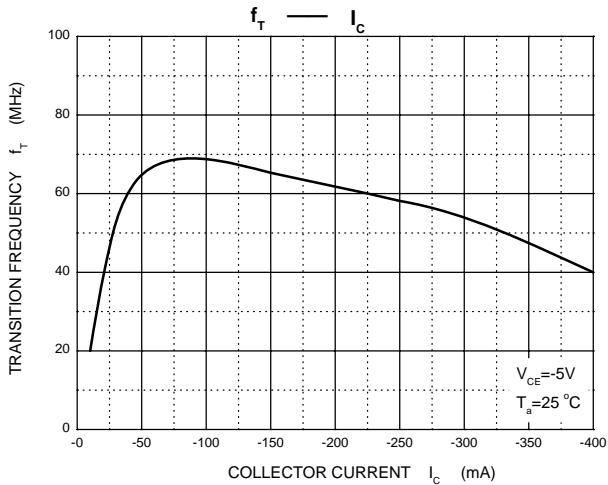
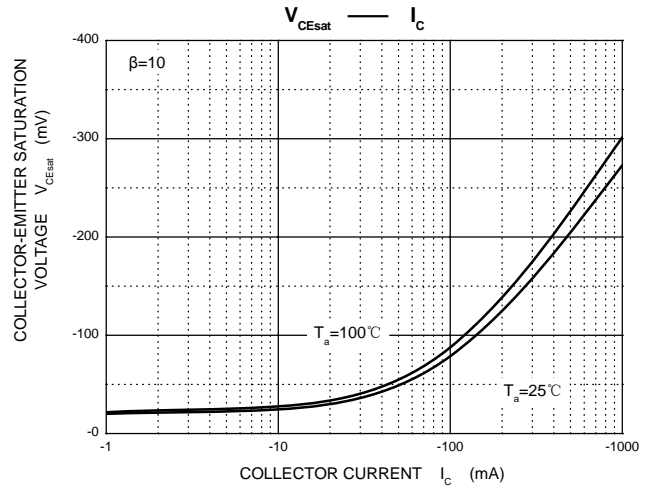
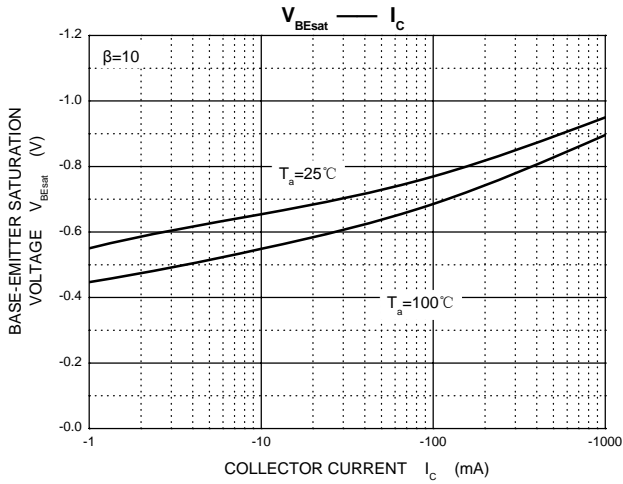
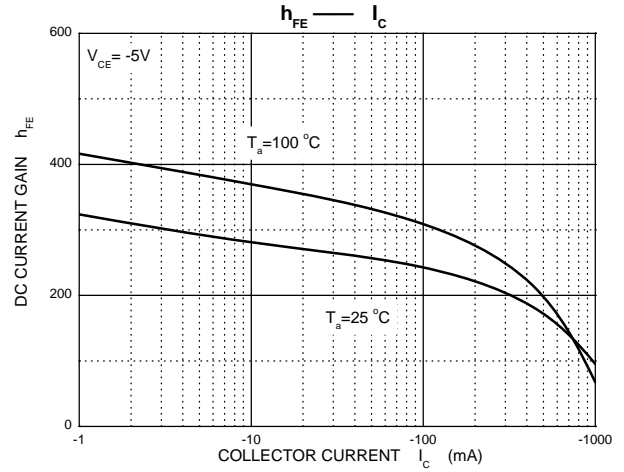
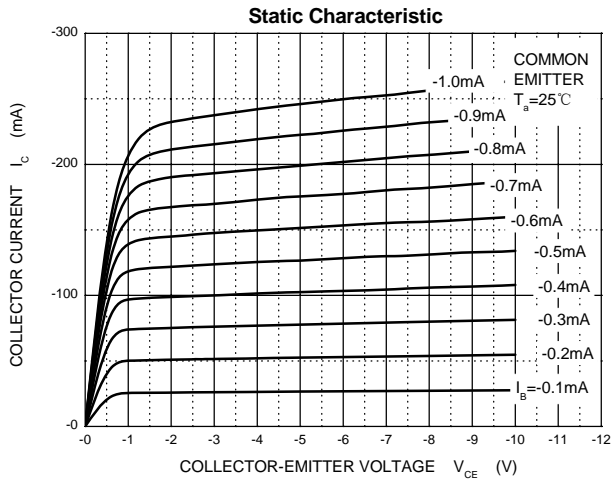

## TO-92MOD Package Outline Dimensions

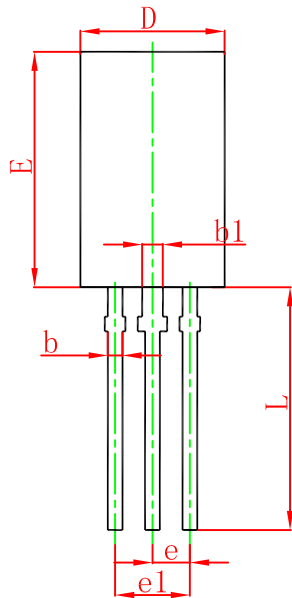
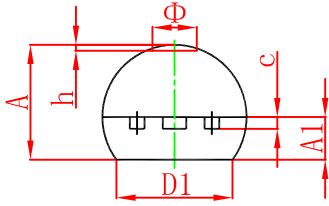

Symbol	Dimensions In Millimeters		Dimensions In Inches	
	Min.	Max.	Min.	Max.
A	4.800	5.000	0.189	0.197
A1	1.730	2.030	0.068	0.080
b	0.440	0.600	0.017	0.024
b1	0.940	1.100	0.037	0.043
c	0.350	0.450	0.014	0.018
D	5.900	6.100	0.232	0.240
D1	4.000		0.157	
E	8.500	8.700	0.335	0.343
e	1.500 TYP.		0.059 TYP.	
e1	2.900	3.100	0.114	0.122
L	13.800	14.200	0.543	0.559
$\Phi$		1.600		0.063
h	0.000	0.380	0.000	0.015

## TO-92MOD Suggested Pad Layout

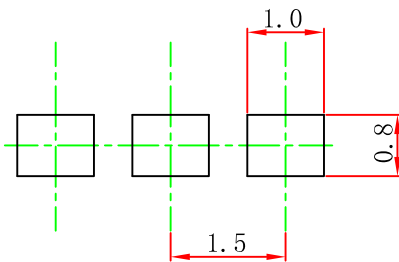

### Note:

1. Controlling dimension: in millimeters.
2. General tolerance:  $\pm 0.05$ mm.
3. The pad layout is for reference purposes only.

### NOTICE

JSCJ reserves the right to make modifications, enhancements, improvements, corrections or other changes without further notice to any product herein. JSCJ does not assume any liability arising out of the application or use of any product described herein.

# TO-92MOD PACKAGE TAPING DIMENSION

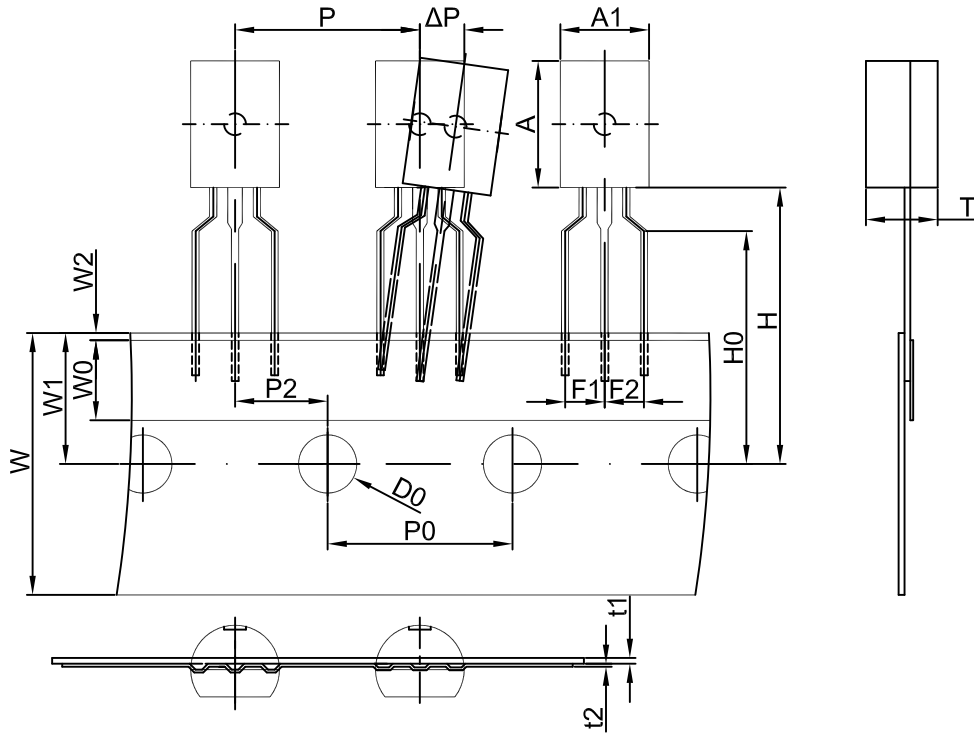

Dimiensions are in millimeter

A1	A	T	P	P0	P2	F1	F2	W
6.0±0.1	8.6±0.1	4.9±0.1	12.7±0.3	12.7±0.2	6.35±0.3	2.5±0.3	2.5±0.3	18.0+1.0/-0.5
W0	W1	W2	H	H0	D0	t1	t2	ΔP
6.0±0.5	9.0±0.5	1.0 MAX.	19.0±2.0/-1	16.0±0.5	4.0±0.2	0.4±0.05	0.2±0.05	0 ± 1.0

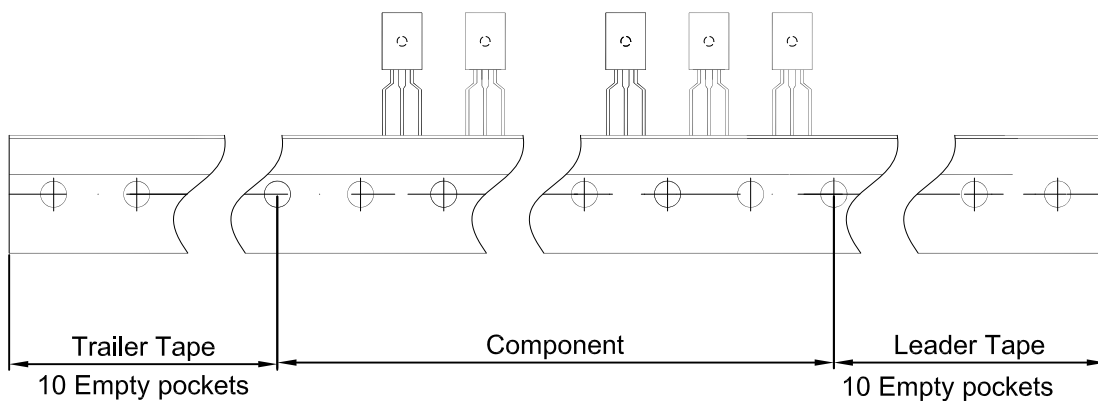

Package	Box	Box Size(mm)	Carton	Carton Size(mm)
TO-92MOD	2000 pcs	333×245×43	20,000 pcs	573×404×266