

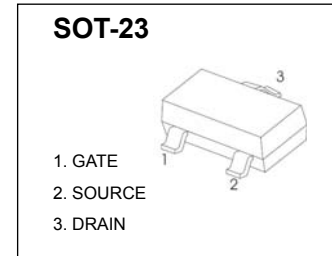

SOT-23 Plastic-Encapsulate MOSFETS

CJ2307 P-Channel 30-V(D-S) MOSFET

$V_{(BR)DSS}$	$R_{DS(on)MAX}$	I_D
-30V	88mΩ@-10V	-2.7A
	138mΩ@-4.5V	



FEATURE

- TrenchFET Power MOSFET

APPLICATION

- Load Switch for Portable Devices

MARKING

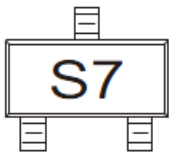

Equivalent Circuit

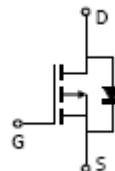

Maximum ratings ($T_a=25^{\circ}C$ unless otherwise noted)

Parameter	Symbol	Value	Unit
Drain-Source Voltage	V_{DS}	-30	V
Gate-Source Voltage	V_{GS}	±20	
Continuous Drain Current ^{a,b}	I_D	-2.7	A
Continuous Source-Drain Current ^{a,b}	I_S	-0.91	
Power Dissipation ^{a,b}	P_D	1.1	W
Thermal Resistance from Junction to Ambient ($t \leq 5s$)	$R_{\theta JA}$	114	$^{\circ}C/W$
Operating Junction Temperature	T_J	150	$^{\circ}C$
Storage Temperature	T_{stg}	-55 ~ +150	

MOSFET ELECTRICAL CHARACTERISTICS

$T_a=25\text{ }^\circ\text{C}$ unless otherwise specified

Parameter	Symbol	Test Condition	Min	Typ	Max	Unit
Static						
Drain-Source Breakdown Voltage	$V_{(BR)DSS}$	$V_{GS} = 0V, I_D = -250\mu A$	-30			V
Gate-Source Threshold Voltage	$V_{GS(th)}$	$V_{DS} = V_{GS}, I_D = -250\mu A$	-1		-3	
Gate-Source Leakage	I_{GSS}	$V_{DS} = 0V, V_{GS} = \pm 20V$			± 100	nA
Zero Gate Voltage Drain Current	I_{DSS}	$V_{DS} = -30V, V_{GS} = 0V$			-1	μA
		$V_{DS} = -30V, V_{GS} = 0V, T_J = 55^\circ C$			-10	
Drain-Source On-State Resistance ^c	$R_{DS(on)}$	$V_{GS} = -4.5V, I_D = -2.5A$		0.110	0.138	Ω
		$V_{GS} = -10V, I_D = -3.5A$		0.073	0.088	
Forward Transconductance ^c	g_{fs}	$V_{DS} = -10V, I_D = -3.5A$		7		S
Dynamic^d						
Input Capacitance	C_{iss}	$V_{DS} = -15V, V_{GS} = 0V, f = 1MHz$		340		μF
Output Capacitance	C_{oss}			67		
Reverse Transfer Capacitance	C_{rss}			51		
Total Gate Charge	Q_g	$V_{DS} = -15V, V_{GS} = -4.5V, I_D = -2.5A$		4.1	6.2	nC
Gate-Source Charge	Q_{gs}			1.3		
Gate-Drain Charge	Q_{gd}			1.8		
Gate Resistance	R_g	$f = 1MHz$		10		Ω
Turn-On Delay Time	$t_{d(on)}$	$V_{DD} = -15V, R_L = 15\Omega, I_D = -1A, V_{GEN} = -4.5V, R_g = 1\Omega$		40	60	ns
Rise Time	t_r			40	60	
Turn-Off Delay Time	$t_{d(off)}$			20	40	
Fall Time	t_f			17	30	
Drain-source Body diode characteristics						
Body Diode Voltage	V_{SD}	$I_S = -0.75A, V_{GS} = 0$		-0.8	-1.2	V

Notes:

- $t = 5s$.
- Surface mounted on 1" x 1" FR4 board.
- Pulse Test : Pulse Width < 300 μs , Duty Cycle $\leq 2\%$.
- Guaranteed by design, not subject to production testing.

Typical Characteristics

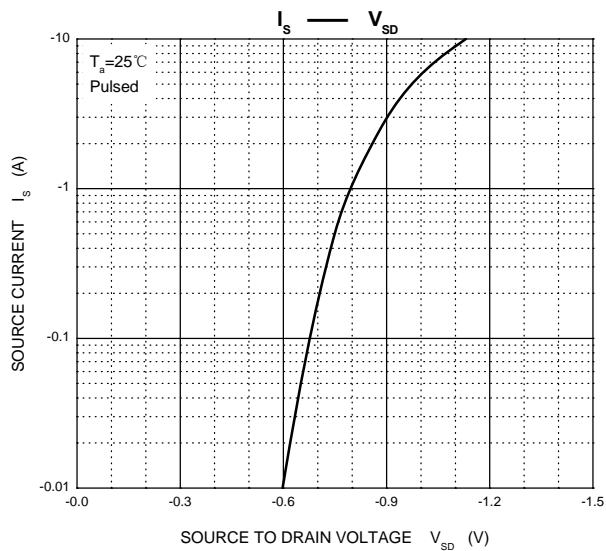
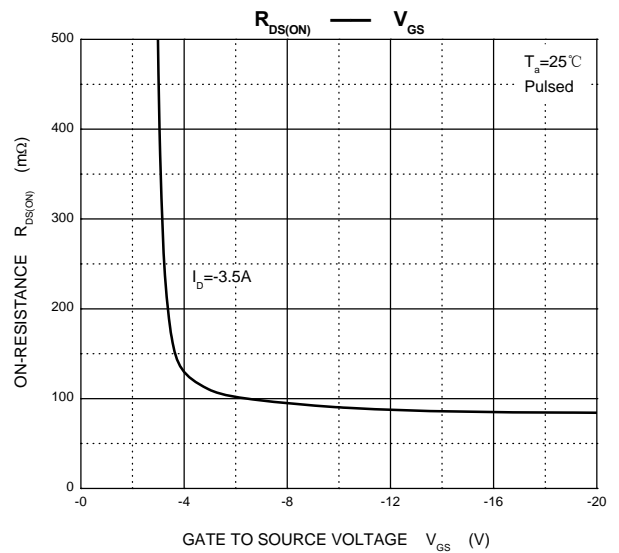
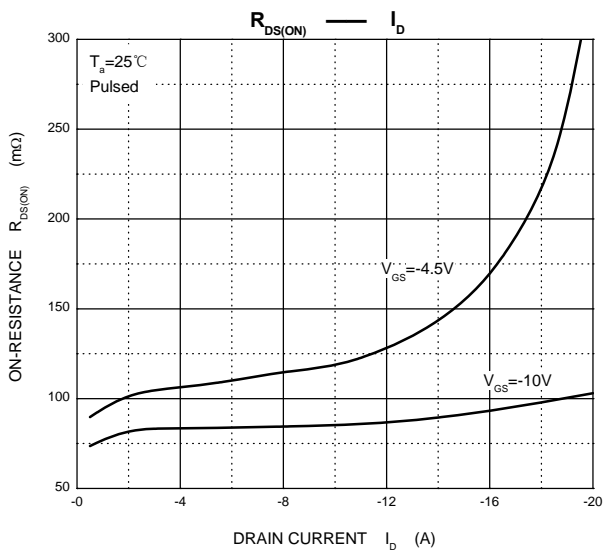
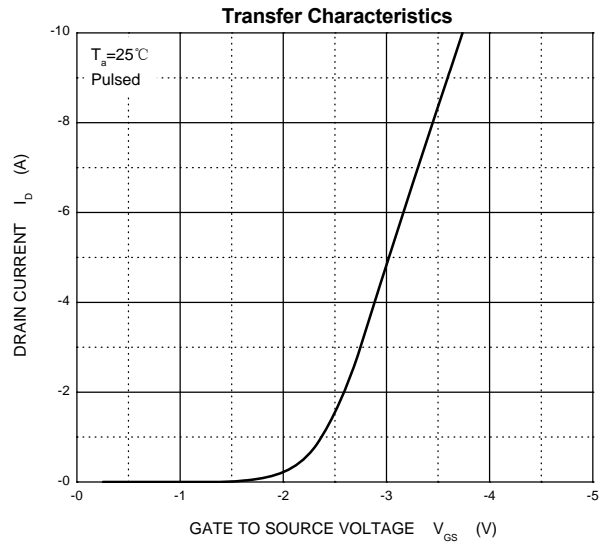
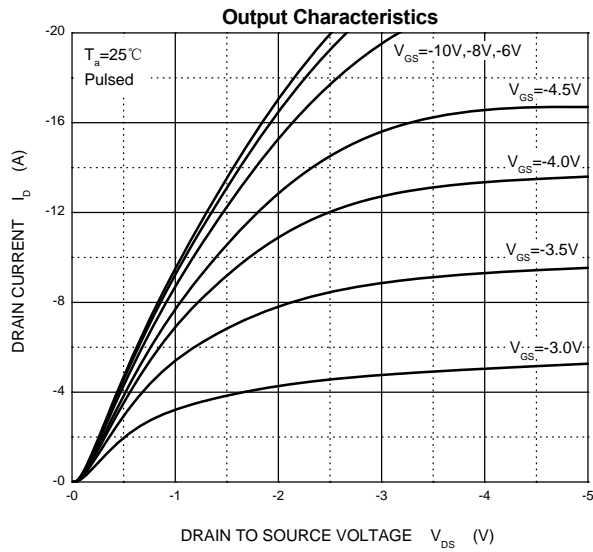

SOT-23 Package Outline Dimensions



Symbol	Dimensions In Millimeters		Dimensions In Inches	
	Min	Max	Min	Max
A	0.900	1.150	0.035	0.045
A1	0.000	0.100	0.000	0.004
A2	0.900	1.050	0.035	0.041
b	0.300	0.500	0.012	0.020
c	0.080	0.150	0.003	0.006
D	2.800	3.000	0.110	0.118
E	1.200	1.400	0.047	0.055
E1	2.250	2.550	0.089	0.100
e	0.950 TYP		0.037 TYP	
e1	1.800	2.000	0.071	0.079
L	0.550 REF		0.022 REF	
L1	0.300	0.500	0.012	0.020
θ	0°	8°	0°	8°

SOT-23 Suggested Pad Layout



Note:

1. Controlling dimension: in millimeters.
2. General tolerance: $\pm 0.05\text{mm}$.
3. The pad layout is for reference purposes only.

NOTICE

JCET reserve the right to make modifications, enhancements, improvements, corrections or other changes without further notice to any product herein. JCET does not assume any liability arising out of the application or use of any product described herein.

SOT-23 Tape and reel

SOT-23 Embossed Carrier Tape

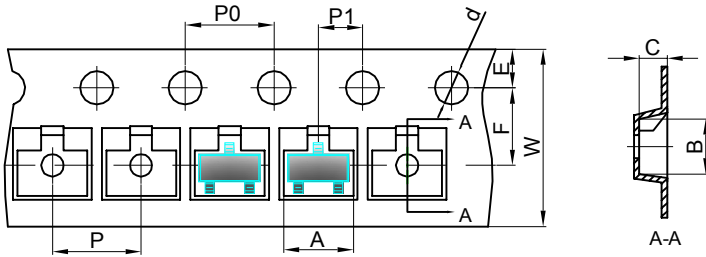

Packaging Description:

SOT-23 parts are shipped in tape. The carrier tape is made from a dissipative (carbon filled) polycarbonate resin. The cover tape is a multilayer film (Heat Activated Adhesive in nature) primarily composed of polyester film, adhesive layer, sealant, and anti-static sprayed agent. These reeled parts in standard option are shipped with 3,000 units per 7" or 17.8cm diameter reel. The reels are clear in color and is made of polystyrene plastic (anti-static coated).

Dimensions are in millimeter										
Pkg type	A	B	C	d	E	F	P0	P	P1	W
SOT-23	3.15	2.77	1.22	Ø1.50	1.75	3.50	4.00	4.00	2.00	8.00

SOT-23 Tape Leader and Trailer

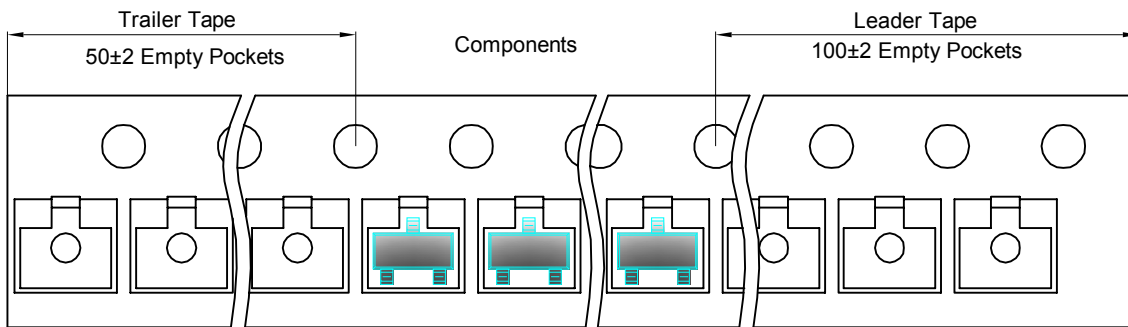

SOT-23 Reel

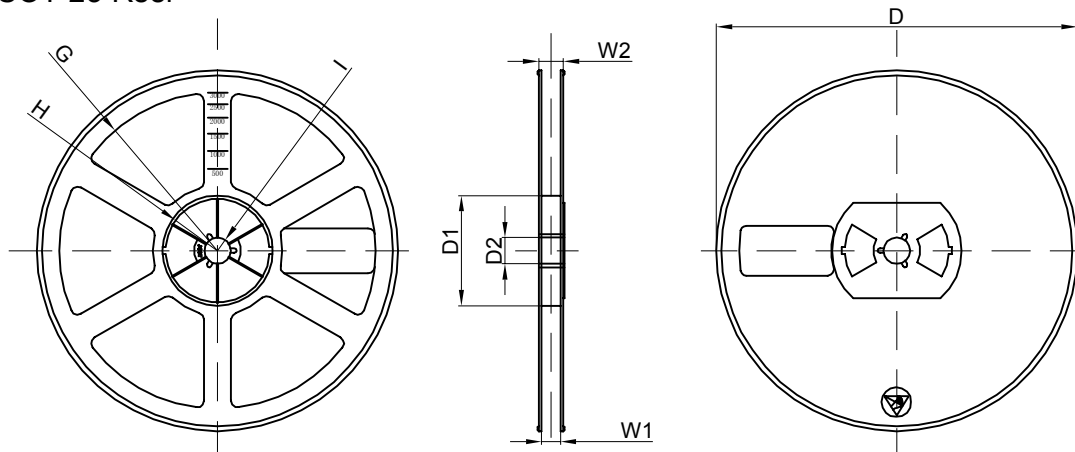

Dimensions are in millimeter								
Reel Option	D	D1	D2	G	H	I	W1	W2
7" Dia	Ø178.00	54.40	13.00	R78.00	R25.60	R6.50	9.50	12.30

REEL	Reel Size	Box	Box Size(mm)	Carton	Carton Size(mm)	G.W.(kg)
3000 pcs	7 inch	30,000 pcs	203×203×195	120,000 pcs	438×438×220	